

# Hi! Let's get started.

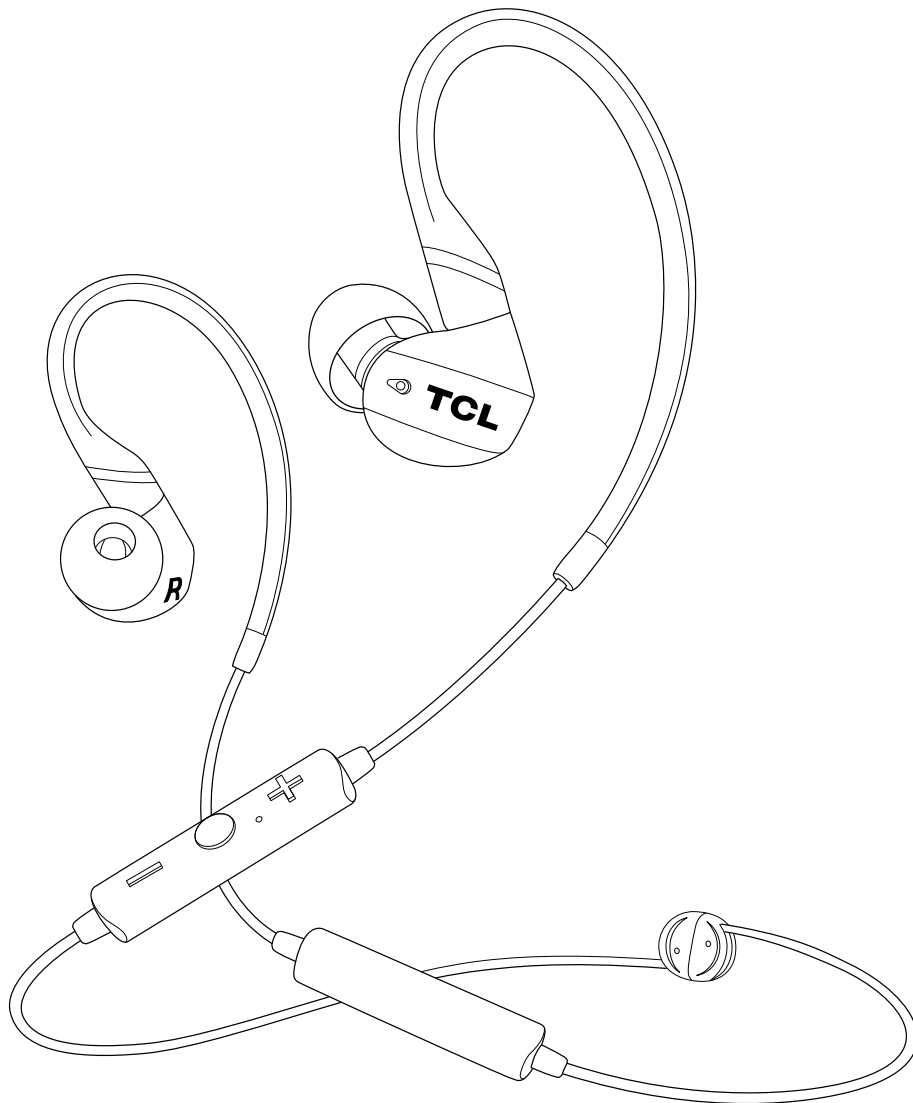

**ACTV100BT**  
User manual

# Contents

---

1	<b>Important safety instructions</b>	3
	Hearing Safety	
	General safety information	

---

2	<b>Welcome</b>	4
	What's in the box	
	Overview of the wireless in-ear headphones	

---

3	<b>Connect your headphones</b>	5
	Charge your headphones	
	Pair the headphones with your smartphone or Bluetooth® devices	

---

4	<b>Use your headphones</b>	6
	Select your earcaps	
	Power your headphones on or off	
	Connect your headphones to your smartphone or Bluetooth® device	
	Music control	
	Voice assistant	
	Call control	
	Switch the voice language	
	Adjust the headphone extension cable	

---

5	<b>Notice</b>	8
	Compliance notice	
	Declaration of conformity	
	Remove the integrated battery	
	Disposal of your old product and battery	

---

6	<b>Notice for US and Canada</b>	9
	Compliance notice for US	
	Compliance notice for Canada	

---

7	<b>Trademarks</b>	10
---	-------------------	----

---

8	<b>FAQ</b>	11
---	------------	----

# 1 Important safety instructions

## Hearing Safety



### Danger

To avoid hearing damage, limit the time you use headphones at high volume and set the volume to a safe level. The louder the volume, the shorter the safe listening time is.

To prevent accidents and damage to ears:

- Listen at reasonable volumes for reasonable periods of time.
- Be careful not to adjust the volume continuously upwards as your hearing adapts.
- Do not turn up the volume so high that you can't hear what's around you.

## General safety information

To prevent damage and malfunctions:

- Do not expose headphones to excessive heat.
- Do not drop your headphones.
- Headphones shall not be exposed to dripping or splashing water.
- Do not allow your headphones to be submerged in water.
- Do not use any cleaning agents containing alcohol, ammonia, benzene, or abrasives.
- If cleaning is required, use a soft cloth, if necessary dampened with a minimum amount of water or diluted mild soap, to clean the product.

### Battery precautions:

- The integrated battery shall not be exposed to excessive heat such as sunshine, fire or the like.

### Operating temperature and humidity:

- Operate or store in a place where temperature is between 0°C (32°F) to 45°C (113°F) (up to 90% relative humidity).
- Battery life may be shorter in high or low temperature conditions.

### Liability:

- This product is designed for use with mobile devices that support Bluetooth® standard specified by Bluetooth® SIG, Inc. and are compatible to the following Bluetooth® profile:

#### Bluetooth® profile

- HSP - Headset profile
- HFP - Hands-free profile
- A2DP - Advanced audio distribution profile (Bluetooth® stereo supported)
- AVRCP - Audio video remote control profile

- It is considered improper use when this product is used for any application not named in this user manual.
- TCL Corporation bears no responsibility for accidents or damage caused by improper use of this product.

# 2 Welcome

Congratulations on the purchase of your new TCL headphones! After it is set up and connected, you can enjoy wireless music and phone calls with high quality sound. You are recommended to read through this user manual which helps you set up, connect and operate the product easily and properly. For more information, visit [www.tcl.com](http://www.tcl.com).

Let's get started.

## What's in the box

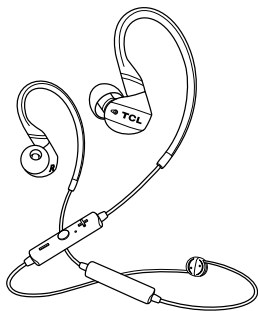

TCL wireless in-ear headphones ACTV100BT (with M size earcaps)



3 pairs of replaceable earcaps

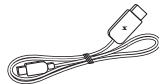

USB cable (for charging)



Quick start guide



Safety sheet

## Overview of the wireless in-ear headphones

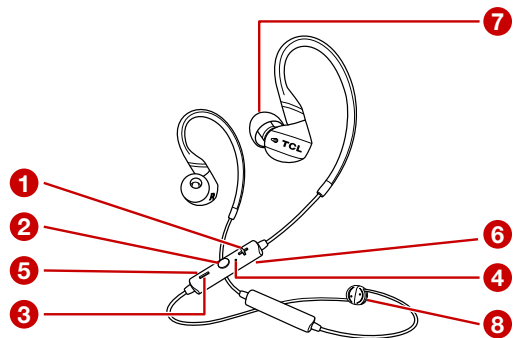

- 1 Turn the volume up.
- 2 Power on or off/Pairing/Music/call control and voice assistant or skip to the next track or previous track.
- 3 Turn the volume down.
- 4 LED indicator
- 5 Micro USB charging slot
- 6 Microphone (on the back)
- 7 Replaceable earcaps
- 8 Cable slider

# 3 Connect your headphones

Before you can make calls and enjoy music with your headphones, follow the instructions below to set up and connect your headphones.

## Charge your headphones

Connect the supplied USB charging cable to:

- The micro USB charging slot on the headphones and;
- The charger/USB port of a computer.  
↳ LED turns white during charging and turns off when the headphones are fully charged.

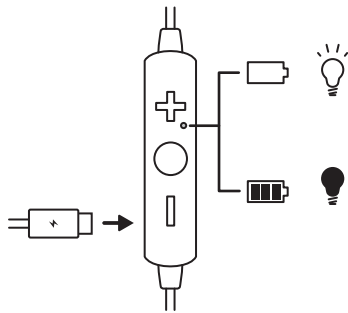

### Note

- For first time use, charge the battery for 5 hours for optimum battery capacity and lifetime.
- After the first time charge, a normal charge takes approximately 2 hours.
- Use only the supplied USB charging cable to charge your headphones to prevent product damage.

### Warning

Only charge with certified USB adaptor DC 5V

## Pair the headphones with your smartphone or Bluetooth® devices

For the first time use, you have to pair the headphones with your smartphone manually.

- 1 Press and hold **O** for 5 seconds until the blue and white LED flashes alternately.  
↳ The blue LED will flash when pairing is successful.
- 2 Turn on the Bluetooth® function of your smartphone.
- 3 Select **TCL ACTV100BT**. Enter '0000' if the headphones password is required.  
↳ The blue LED will flash when pairing is successful.

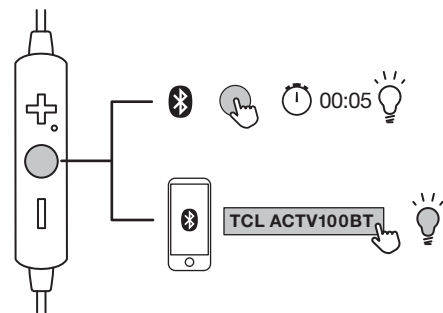

### Note

- The headphones can save up to 8 different devices you have connected. If you connect to more than 8 devices, the earliest connected device is replaced by the last connected one.
- Make sure your smartphone or device has Bluetooth® capability and is compatible to the headphones (see 'Bluetooth® profile' on page 3).

# 4 Use your headphones

You can now enjoy wireless music and make your phone calls with your headphones.

## Select your earcaps

Replaceable earcaps will be offered with the headphones. You can select a pair which fits your ear the best.

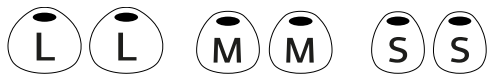

## Power your headphones on or off

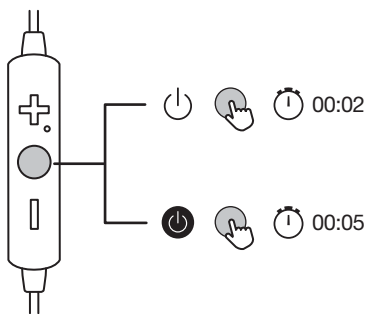

Press for 2 seconds to power on your headphones.  
Press for 5 seconds to power off your headphones.

## Connect your headphones to your smartphone or Bluetooth® device

- 1 Turn on your smartphone or Bluetooth® device.
- 2 Turn on your headphones.
  - ↳ The blue LED flashes.
  - ↳ The headphones are reconnected to the last connected smartphone/Bluetooth® device automatically.

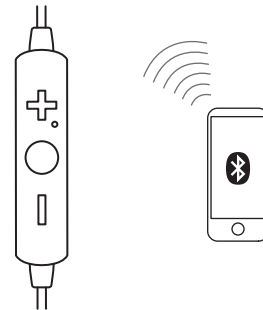

### Note

- You are recommended to turn on the smartphone/Bluetooth® device or activate the Bluetooth® feature before turning on the headphones. Otherwise, you have to reconnect the headphones and smartphone/Bluetooth® device manually.
- If the headphones fail to connect to any Bluetooth® device within 5 minutes, the headphones will switch off automatically to save the battery life.

## Music control

Music control	Operation
Volume up	Press
Skip forward	Press  twice
Play or pause	Press  once
Skip backward	Press  thrice
Volume down	Press

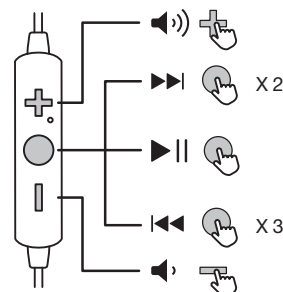

## Voice assistant

Phone voice commands enable you to speak to **Siri**® or **Google Assistant**™ on your smartphone using your headphones. For more information on using **Siri**® or **Google Assistant**™, please consult the user manual of your smartphone or Bluetooth® device.

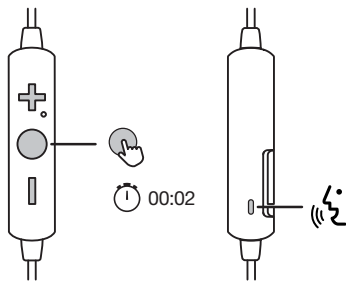

Press **○** for 2 seconds to activate **Siri**® or **Google Assistant**™. You will hear the start-up sound. Make a request to **Siri**® or **Google Assistant**™ through the headphones' microphone.

## Call control

Call control	Operation
Mute/unmute the microphone during a call	Press <b>+</b> and <b>=</b>
Pick up or hang up a call	Press <b>○</b> once
Switch to another caller during a call	Press <b>○</b> twice
Reject an incoming call	Press and hold <b>○</b> for 2 seconds
Adjust the volume	Press <b>+</b> or <b>=</b>

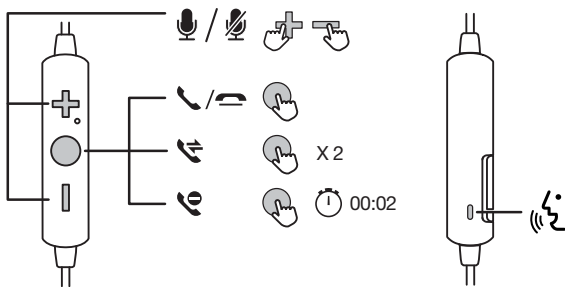

## Switch the voice language

After powering on the headphones, you will hear voice notifications of different headphone status such as when the battery level is low or when the headphones are connected to the smartphone or Bluetooth® device. To switch to another voice language, see the following steps.

- 1 Make sure the headphones are powered on.
- 2 Press and hold **+** and **=** simultaneously for 5 seconds.
  - ↳ You will hear a sound signal to confirm that the voice language has been changed.

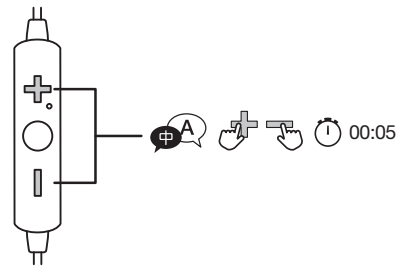

### Tip

- There are two voice languages (English and Mandarin Chinese) available for selection.

## Adjust the headphone extension cable

You can extend or reduce the length of the headphone cable to fit your needs.

1. Pull the cable slider to reduce the cable length.
2. Pull the cable slowly to extend the cable length.

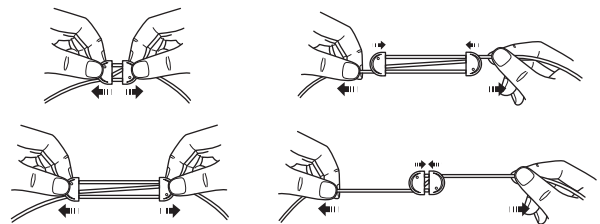

### Note

- Adjust the headphone cable length gently to prevent it from tangling.

# 5 Notice

---

## Compliance notice

### EMF

This product complies with all applicable standards and regulations regarding exposure to electromagnetic fields.

---

## Declaration of conformity

Hereby, TCL Corporation declares that this product is in compliance with the essential requirements and other relevant provisions of Directive 2014/53/EU. You can find the Declaration of Conformity on [www.tcl.com](http://www.tcl.com)

---

## Remove the integrated battery

Check your country's local waste regulations for the proper disposal of electronic products. To protect the environment, remove and recycle the headphone battery before disposing of them.

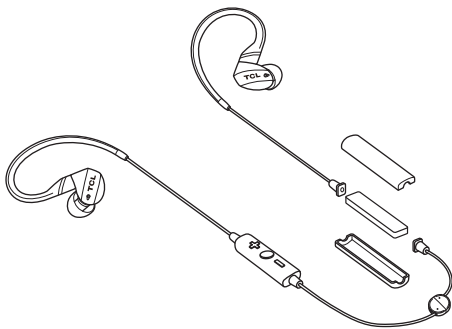

Lithium polymer battery (0.37Wh)

---

## Disposal of your old product and battery

### Environmental protection and sustainability

We have omitted all unnecessary packaging and make sure it is eco-friendly and sustainable.



Your product is designed and manufactured with high quality materials and components, which can be recycled and reused. Please observe the local regulations regarding the disposal of packaging materials, exhausted batteries and old equipment. For recycling information, please visit [www.tcl.com](http://www.tcl.com)



This symbol on a product means that the product is covered by European Directive 2012/19/EU.



This symbol means that the product contains a built-in rechargeable battery covered by European Directive 2013/56/EU which cannot be disposed of with normal household waste. We strongly advise you to take your product to an official collection point.



# 6 Notice for US and Canada

---

## Compliance notice for US

This device complies with the FCC rules. Operation is subject to the following two conditions:

1. This device may not cause harmful interference, and
2. This device must accept any interference received, including interference that may cause undesired operation.

### FCC rules

This equipment has been tested and found to comply with the limits for a Class B digital device, pursuant to Part 15 of the FCC Rules. These limits are designed to provide reasonable protection against harmful interference in a residential installation. This equipment generates, uses and can radiate radio frequency energy and, if not installed and used in accordance with the instructions, may cause harmful interference to radio communications. However, there is no guarantee that interference will not occur in a particular installation. If this equipment does cause harmful interference to radio or television reception, which can be determined by turning the equipment off and on, the user is encouraged to try to correct the interference by one or more of the following measures:

- Reorient or relocate the receiving antenna.
- Increase the separation between the equipment and receiver.
- Connect the equipment into an outlet on a circuit different from that to which the receiver is connected.
- Consult the dealer or an experienced radio/TV technician for help.

### FCC Radiation Exposure Statement:

This equipment complies with FCC radiation exposure limits set forth for an uncontrolled environment. This transmitter must not be co-located or operated in conjunction with any other antenna or transmitter.

## Compliance notice for Canada

This device complies with Industry Canada licence-exempt RSS standard(s). Operation is subject to the following two conditions: (1) this device may not cause harmful interference, and (2) this device must accept any interference received, including interference that may cause undesired operation.

CAN ICES-3(B)/NMB-3(B)

### IC Radiation Exposure Statement

This equipment complies with Canada radiation exposure limits set forth for uncontrolled environments. This transmitter must not be co-located or operating in conjunction with any other antenna or transmitter.

**Caution:** The user is cautioned that changes or modifications not expressly approved by the party responsible for compliance could void the user's authority to operate the equipment.



# 7 Trademarks

---

## Bluetooth®

The Bluetooth® word mark and logos are registered trademarks owned by Bluetooth® SIG, Inc. and any use of such marks by TCL Corporation under license.

## Siri®

Siri® is a trademark of Apple Inc., registered in the U.S. and other countries.

## Google™

Google™ and the Google™ Logo are registered trademarks of Google™ Inc., and Google Assistant™ is a trademark of Google™, Inc.

## TCL

TCL is a registered trademark of TCL Corporation in the U.S. and Canada.

## ACTV

ACTV is a trademark of TCL North America.

## All other trademarks and trade names

are the property of their respective owners.

# 8 FAQ

---

I cannot switch on the headphones.

- Your headphones do not have enough battery power. Charge your headphones (see 'Charge your headphones' on page 5).

The headphones are not connected to my smartphone automatically.

- Make sure you switch on your smartphone before you switch on the headphones. Make sure the Bluetooth® function of your smartphone is switched on.

The headphones keep on disconnecting.

- Your headphones do not have enough battery power. Charge your headphones (see 'Charge your headphones' on page 5).
- Make sure the headphones and Bluetooth® device are within the operation range. Remove any unnecessary Bluetooth® devices.
- Remove the headphones from the pairing list and pair them with your device again.

The headphones do not pair with my device.

- Make sure you follow the steps described in this user manual.
- Make sure the headphones have entered the pairing mode. Press and hold  until the blue and white LED flashes alternately.

I cannot find the headphones model name on the pairing list of my Bluetooth® device to make a first time connection.

- Follow the steps described in this user manual and pair the headphones with your device manually again (see 'Pair the headphones with your smartphone or Bluetooth® devices' on page 5).

Why does the music play on my smartphone speaker, but not through my headphones?

- Make sure you have already selected on your smartphone to listen to music through the headphones. For information, consult the user manual of your smartphone.

I cannot hear the other side's speaking.

- Adjust the volume of your headphones.
- Adjust the volume of your connected Bluetooth® device.

The other side cannot hear my voice.

- Make sure you speak close to the microphone.
- Make sure the microphone is not muted.

The audio quality is poor and crackling noise can be heard.

- Make sure the Bluetooth® device is within the operation range. Reduce the distance or remove obstacles between your headphones and Bluetooth® device.

The audio quality is poor when streaming from the smartphone or audio streaming does not work at all.

- Make sure your smartphone supports both HFP - Hands-free profile and A2DP - Advanced audio distribution profile (Bluetooth® stereo supported).

I cannot control music functions on my Bluetooth® device.

- Make sure the Bluetooth® audio source supports AVRCP - Audio video remote control profile.

Where do I take my headphones to dispose of them?

- To find the closest electronics recycling solution to you, please visit [www.tcl.com](http://www.tcl.com)

For further support, visit [www.tcl.com](http://www.tcl.com)

---

# **WE ARE READY TO HELP**

**contact us first  
with any questions**

---

For more details or for help visit:  
[www.tcl.com](http://www.tcl.com)

2019© TCL Entertainment Solutions Limited. All rights reserved.  
This product has been manufactured by and is sold under the  
responsibility of TCL Entertainment Solutions Limited.

ACTV100BT\_EN\_UM\_v1.0