

TCL



REGISTER NOW
See inside for details &
protect your purchase

Hi! Let's get started.



S-Series
S470G

Register and protect your purchase

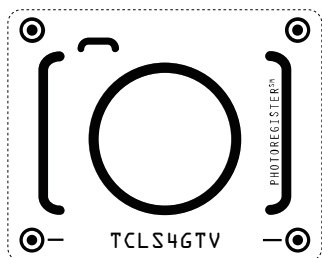

TEXT TO REGISTER

Text a photo of the camera icon to **71403**

Or register online at register.tcl.com

Need help? Visit photoregister.com/help or text HELP to 71403

Add a TCL Protection Plan when you register your product and be covered from life's mishaps

Thank you for choosing TCL. We want your ownership experience to bring you as much joy as the television you purchased does, so we're offering you a special price on TCL Protection Plans when you purchase during registration. Add a TCL Protection Plan within your first 30 days of ownership to receive the best value and we won't let anything get in the way of your viewing pleasure.

Benefits & Description

	PROTECT	PROTECT PLUS
Extended Manufacturer Coverage Extended parts & labor coverage for manufacturer defects.	Up To 4 Years	Up To 4 Years
Priority Service Free shipping and rapid turn-around time.	3-5 Days	3-5 Days
Product Replacement Free 1-time replacement if product cannot be fixed.	+	+
TCL Parts & Service Genuine TCL parts & factory certified service.	+	+
No Deductible \$0 out of pocket expense.	+	+
Pixel Repair and Burn-In Coverage Don't let shadows or off pixels prevent you from clear viewing.	+	+
Accidental Damage Protection Coverage for drops, breaks and spills starts after 30 days.		+
Complimentary Remove & Reinstall Don't risk it-we'll remove and reinstall televisions 65" and larger.		+
Lost Your Remote? No problem! We'll replace your remote, so you never have to leave your couch. <i>One time only.</i>		+

DO NOT RETURN TO STORE

**WE ARE
READY TO
HELP** contact us first
with any questions







TCL SUPPORT:
support.tcl.com/us
1-877-300-9576



**TAKE CARE WHEN
REMOVING THE TV**

Important Information

 <div style="background-color: black; color: white; padding: 5px; text-align: center; font-weight: bold; margin-bottom: 5px;">CAUTION</div> <div style="border: 1px solid black; padding: 5px; text-align: center;">RISK OF ELECTRIC SHOCK. DO NOT OPEN.</div> 	 This symbol indicates that this product incorporates double insulation between hazardous main voltage and user accessible parts. When servicing, use only identical replacement parts.
<p>CAUTION: Neutral fusing. Disconnect mains before servicing. Caution: To reduce the risk of electric shock, do not remove cover (or back). No user serviceable parts inside. Refer servicing to qualified service personnel.</p>	
 This symbol indicates "dangerous voltage" inside the product that presents a risk of electric shock or personal injury.	 This symbol indicates important instructions accompanying the product.

WARNING
 To reduce the risk of fire or electric shock, do not expose this product to rain or moisture. This product should not be exposed to dripping or splashing. No objects filled with liquids, such as vases, should be placed on the apparatus.

WARNING
 The TV is unstable if it is not properly attached to the base or mounted to the wall. Please follow the base or wall mounting instructions provided in the User's Guide to ensure your safety.

Warning: The batteries should not be exposed to excessive heat, such as prolonged direct sunlight, open flame, or fire of any kind. Refer to the identification/rating label located on the back panel of your product for its proper operating voltage.

Cable TV Installer: This reminder is provided to call your attention to Article 820-40 of the National Electrical Code (Section 54 of the Canadian Electrical Code, Part 1) which provides guidelines for proper grounding and, in particular, specifies that the cable ground should be connected to the grounding system of the building as close to the point of cable entry as practical.

Important: This television is a table model and is designed to sit on a firm, flat surface. Do not place the TV on soft carpeting or on a similar surface as this may cause the ventilation slots located on the bottom of the unit to be blocked and may result in reduced product lifespan from overheating. To assure adequate ventilation for this product, maintain a spacing of one (1) inch from the top and side of the TV receiver and two (2) inches from the rear of the TV receiver and other surfaces. Make sure the TV stand or base you use is of adequate size and strength to prevent the TV from being accidentally tipped over, pushed off, or pulled off. This may cause personal injury and/or damage the TV. Refer to the Important Safety Instructions on the next page.

The Power button  on this TV and your remote control puts the TV into a very low-power standby mode but will not completely turn the power off. In order to completely shut the power off, you will need to disconnect the power cord from the outlet. The mains plug/appliance coupler is used to completely turn off the device. If you prefer to completely turn off the device, you should install the TV in a manner that allows you to disconnect the power cord when desired.

Product Information

Keep your sales receipt to obtain warranty parts and service and for proof of purchase. Attach it here and record the serial and model numbers in case you need them. These numbers are located on the product.

Keep the apparatus at least 8 inches away from the human body.

Input	Signal Compatibility
Antenna/Cable	480i, 480p, 720p, 1080i (NTSC, ATSC, and QAM formats)
Composite Video	480i
HDMI	480i, 480p, 720p/60Hz, 1080i/60Hz, 1080p/60Hz, 2160p/24/30/60Hz

For the best viewing experience, remove the energy guide label from the TV front panel or TV screen before use.

Model No. _____

Serial No. _____

Purchase Date _____

Dealer/Address/Phone _____

Important Safety Instructions

1. Read these instructions.
2. Keep these instructions.
3. Heed all warnings.
4. Follow all instructions.
5. Do not use this apparatus near water.
6. Clean only with a dry cloth.
7. Do not block any ventilation openings. Install in accordance with the manufacturer's instructions.
8. Do not install near any heat sources such as radiators, heat registers, stoves, or other apparatus (including amplifiers) that produce heat.
9. Protect the power cord from being walked on or pinched particularly at plugs, convenience receptacles, and the point where they exit from the apparatus.
10. WARNING: Please refer the information on exterior bottom enclosure for electrical and safety information before installing or operating the apparatus.
11. WARNING: The main plug is used to disconnect the device and should remain readily operable.
12. When not in use, tie up the power cordset with a cable tie or with something similar. It should not be near sharp edges as it may cause abrasion of the power cordset. When put into use again, please make sure the power cordset is not damaged. If any damage is found, please use a replacement power cord specified by the manufacturer or that is identical to the original one.
13. No open flame sources, such as lit candles, should be placed on, under, or near the apparatus.
14. Unplug this apparatus during lightning storms or when unused for long periods of time.
15. Only use attachments/accessories specified by the manufacturer.
16. Use only with the cart, stand, tripod, bracket, or table specified by the manufacturer, or sold with the apparatus. When a cart is used, use caution when moving the cart/apparatus combination to avoid any injury.
17. Refer all servicing to qualified service personnel. Servicing is required when the apparatus has been damaged in any way, such as power-supply cord or plug is damaged, liquid has been spilled or objects have fallen into the apparatus, the apparatus has been exposed to rain or moisture, does not operate normally, or has been dropped.
18. For safe operation of the apparatus, please follow these installation requirements:
Keep at least 2 inches of ventilation space between the rear cover of the apparatus and the wall. Keep at least 1 inch of ventilation space between the apparatus and all other surfaces. Do not allow any of the apparatus' ventilation openings to be blocked by objects that might obstruct them, such as newspapers, curtains, table-cloths or any other objects. Do not expose the apparatus to any external heat sources. Do not place any heat sources such as candles, lamps, etc. on the apparatus. Do not expose the device to high levels of humidity or to any possible sources of moisture. When disposing of used batteries from the remote control, consult local regulations regarding proper disposal.
19. If an outside antenna or cable system is connected to the product, be sure the antenna or cable system is grounded so as to provide some protection against voltage surges and built-up static charges. Section 810 of the National Electrical Code, ANSI/NFPA No. 70-2011 (Section 54 of Canadian Electrical Code, Part 1) provides information with respect to proper grounding of the mast and supporting structure, grounding of the lead in wire to an antenna-discharge unit, size of grounding conductors, location of antenna discharge unit, connection to grounding electrodes, and requirements for the grounding electrode. See following example:

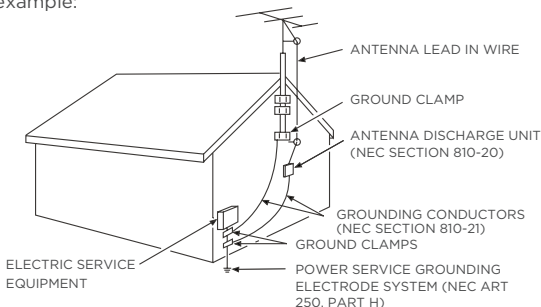



The terms HDMI, HDMI High-Definition Multimedia Interface, HDMI Trade Dress and the HDMI Logos are trademarks or registered trademarks of HDMI Licensing Administrator, Inc.



Dolby, Dolby Vision, Dolby Atmos, and the double-D symbol are registered trademarks of Dolby Laboratories Licensing Corporation. Manufactured under license from Dolby Laboratories. Confidential unpublished works. Copyright © 2012-2022 Dolby Laboratories. All rights reserved.



For DTS patents, see <http://patents.dts.com>. Manufactured under license from DTS, Inc. or DTS Licensing Limited. DTS, DTS-HD Master Audio, DTS-HD, Virtual:X, and the DTS-HD logo are registered trademarks or trademarks of DTS, Inc. in the United States and other countries. © 2021 DTS, Inc. ALL RIGHTS RESERVED.

FCC Information

This equipment has been tested and found to comply with the limits for a Class B digital device, pursuant to Part 15 of the FCC Rules. These limits are designed to provide reasonable protection against harmful interference in a residential installation. This equipment generates, uses, and can radiate radio frequency energy and, if not installed and used in accordance with the instructions, may cause harmful interference to radio communications. However, there is no guarantee that interference will not occur in a particular installation. If this equipment does cause harmful interference to radio or television reception, which can be determined by turning the equipment off and on, the user is encouraged to try to correct the interference by one or more of the following measures:

- Reorient or relocate the receiving antenna.
- Increase the separation between the equipment and receiver.
- Connect the equipment into an outlet on a circuit different from that to which the receiver is connected.
- Consult the dealer or an experienced radio/TV technician for help.

This Class B digital apparatus complies with Canadian ICES-003.

S-series, include models (S470G)

This device complies with part 15 of the FCC Rules. Operation is subject to the following two conditions:

- (1) This device may not cause harmful interference, and
- (2) this device must accept any interference received, including interference that may cause undesired operation.

Supplier Name: TTE Technology, Inc. (dba TCL North America)

Supplier Address: 189 Technology Drive, Irvine, CA 92618, USA

Supplier phone number and internet contact information: 1-877-300-9576 support.tcl.com/us

Battery CAUTION & Disposal Information

1. For best results, use alkaline-type batteries.
2. Do not mix Alkaline, Standard (Carbon-Zinc), or Rechargeable (Nickel Cadmium or Nickel Metal Hydride) batteries.
3. Always replace depleted batteries with two same brand-new batteries from the same manufacturer. Never use damaged batteries.
4. Do not use Rechargeable (Nickel Cadmium or Nickel Metal Hydride) batteries.
5. Install only new batteries of the same type in your product. There is a risk of fire or explosion if the battery is replaced by an incorrect type.
6. Do not mix old and new batteries.
7. Batteries should not be exposed to excessive heat, such as prolonged direct sunlight, open flame, or fire of any kind as it may result in an explosion, or leakage of flammable liquid, or gas.
8. Batteries should not be exposed to extremely low air pressure as it may result in an explosion or the leakage of flammable liquid or gas.
9. Failure to insert batteries in the correct polarity, as indicated in the battery compartment, may shorten the life of the batteries or cause batteries to leak.
10. Batteries should be recycled or disposed of as per state and local guidelines. Do not dispose of batteries in a fire, hot oven, or mechanically crushing or cutting a battery, which may result in an explosion.

ELECTRONICS & PACKAGING RECYCLING INFORMATION

For information on recycling your old TVs, sound bars, and home comfort products, and to find drop-off locations in your area, please visit the "Electronics Recycling" area of the TCL website at www.tcl.com. Click on our convenient interactive map to quickly locate a solution in your community. TCL encourages consumers to always look for a recycling or reuse alternative to discarding televisions and other electronics, and in many areas TCL has programs for consumers to drop-off and recycle televisions free of charge.

Look for convenient How2Recycle® labels on the product box for help preparing your new TV packaging for recycling. These labels show important information identifying the various types of packaging material included with your new TV along with easy-to-understand recycling instructions.

Warning: To avoid the danger of suffocation, keep plastic packaging away from babies, children, and pets. Do not use packaging bags in cribs, beds, carriages, or playpens.

What's in the box



TCL TV



43"/50"/55"/
/58"/65"/70"

or

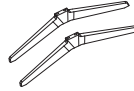

75"

TV stands



Power cable

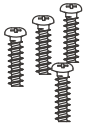

43": ST4x25mm

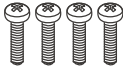

50"/55": M4x25mm
58"/65": M4X36mm
70": M4X20mm
75": M5X50mm

4 x Stand screws
(The 75" screws are
in the stand bag)



4 x Wall
Mount Screws
(M6X14mm)
(70" screws included)



2 x AAA batteries
for remote



HDMI cable

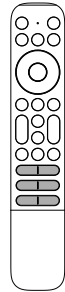

TV remote

What you need

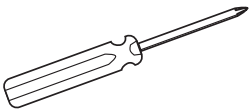

Phillips head
screwdriver

Make the most of your TV

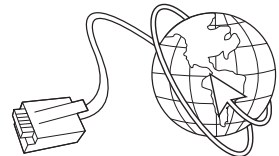
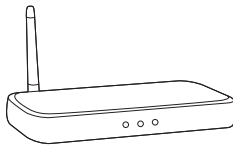

Router + Internet Connection
(needed for streaming)

For additional support, please visit support.tcl.com/us

Step 1 Set up your TV

Ready for the step-by-step? You're only minutes away from TV bliss!

Warning: To avoid the danger of suffocation, keep plastic packaging away from babies, children, and pets. Do not use packaging bags in cribs, beds, carriages, or playpens.

Remove your TV from the box

Be careful, it's heavy!

To use the stand

- A** To prevent damage to the screen, carefully place your TV on a soft, cushioned surface.
- B** Align the stands with the screw holes located on the TV. Secure the stands to the TV with four (4) screws.

Note: Make sure the installation direction of the stand is the same as illustrated.

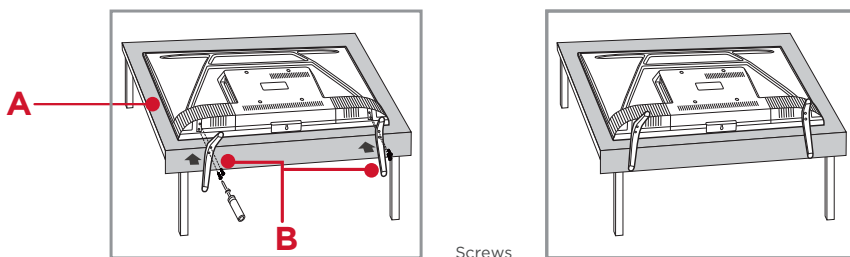

(43": ST4X25mm 50"/55": M4X25mm 58"/65": M4x36mm 70": M4X20mm 75": M5X50mm)

Warning:

Never place a television set in an unstable location. A television set may fall, causing serious personal injury or death. Many injuries, particularly to children, can be avoided by taking simple precautions such as:

- Using cabinets or stands recommended by the manufacturer of the television set.
- Only using furniture that can safely support the television set.
- Ensuring the television set is not overhanging the edge of the supporting furniture.
- Not placing the television set on tall furniture (for example, cupboards or bookcases) without anchoring both the furniture and the television set to a suitable support.
- Not placing the television set on cloth or other materials that may be located between the television set and supporting furniture.
- Educating children about the dangers of climbing on furniture to reach the television set or its controls.
- NEVER place items that might encourage children to climb, such as toys and remote controls, on the top of the television or furniture on which the television is placed.
- ALWAYS route cords and cables connected to your television so they cannot be tripped over, pulled or grabbed.

If your existing television set is being retained and relocated, the same considerations as above should be applied.

Optional - To mount on a wall

(Wall mount hardware and accessories are not included)

To mount on a wall

Preparation must be done before mounting your TV on a wall.

Note: Do not place your TV in a location exposed to direct sunlight, heat, fire, or moisture. Exposure will damage the TV.

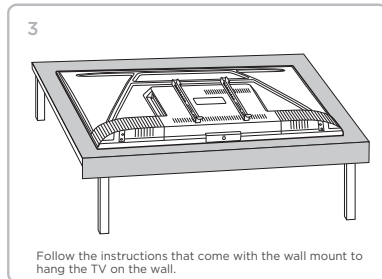
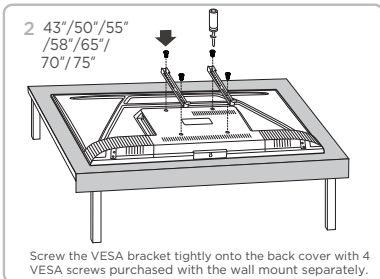
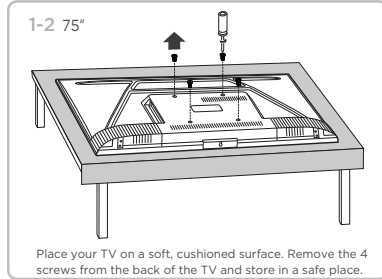
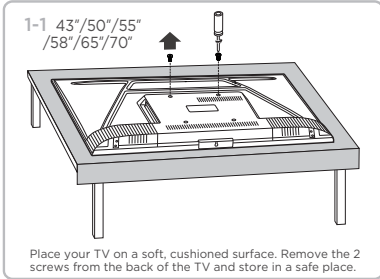

If you are mounting your TV to the wall, don't attach the stands.

To mount your TV to the wall, purchase a VESA wall mount

Models of 43"	Purchase a VESA 200x200 (4 M6x12mm screws)
Models of 50"	Purchase a VESA 200x200 (4 M6x12mm screws)
Models of 55"	Purchase a VESA 200x200 (4 M6x12mm screws)
Models of 58"	Purchase a VESA 200x200 (4 M6x12mm screws)
Models of 65"	Purchase a VESA 200x200 (4 M6x12mm screws)
Models of 70"	Purchase a VESA 200x300 (4 M6x14mm screws) Note: you can use the screws in accessory bag.
Models of 75"	Purchase a VESA 300x300 (4 M6x25mm screws)

The VESA number is the horizontal and vertical measurement of the mounting holes. For example, 200X200 refers to the fact that the mounting measurements are 200mm horizontally and 200mm vertically.

Follow the instructions that come with the wall mount.

Your wall mount must be able to bear a minimum of five times the TV's net weight to avoid causing damage.

Warning: This product should only be mounted by a professional installer.

Warning: **Never install or mount** this product to the ceiling with the screen side facing down. Installing or mounting this product to the ceiling or the underside of a structure or surface is hazardous and may result in personal injury and/or property damage.

Step 2 Power up

In this step, we'll make sure all systems are a GO!

Connect your power cable to the TV, then plug it into the wall outlet.

Power your TV remote by inserting the included batteries.

If applicable, connect external devices by referencing port label and descriptions on Page 9.

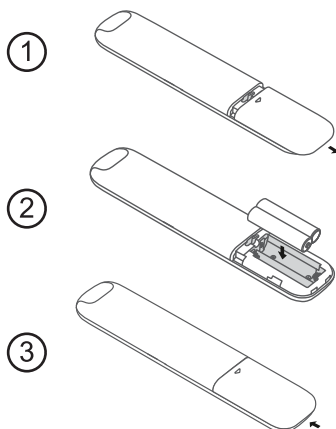

Insert batteries in the correct polarity as indicated in the battery compartment.



















Power Tip! Always replace depleted batteries with two same brand-new batteries from the same manufacturer. Never use damaged batteries.

If your remote gets warm/hot during use, discontinue use and contact customer support immediately at support.tcl.com/us.

Review the Battery CAUTION & Disposal Information on page 3.

Step 3 Grab your remote

The TV remote should feel right at home in your hand. We designed it to be incredibly intuitive for watching TV and navigating on-screen menus.

-  **INPUT** To select input source and display the quick panel
-  **REMOTE MICROPHONE** Talk to the remote microphone after pressing the Google Assistant button
-  **POWER** Turn TV on and off
-  **PROFILE SELECTOR** Switch profile
-  **GOOGLE ASSISTANT BUTTON** Press to activate the remote's Google Assistant microphone. Search content through your voice by holding down the button.
-  **SETTINGS** To display the dashboard menu
-  **CIRCULAR D-PAD** Navigation direction buttons (Up/Down/Left/Right)
-  **OK BUTTON** To confirm an entry or selection
-  **BACK** Return to previous screen
-  **TCL HOME** To access the TV homepage
-  **LIVE GUIDE** Open live TV EPG
-  **VOLUME** Raise and lower volume
-  **CHANNEL** To change channels
-  **QUICK SETTINGS** Open the quick menu
-  **MUTE** Press the button to mute the sound
-  **TV PLUS** Access to network Live Channel
-  **VIRTUAL KEYBOARD** Open virtual keyboard on screen
-  **INFORMATION** In TV source, press to view the program information

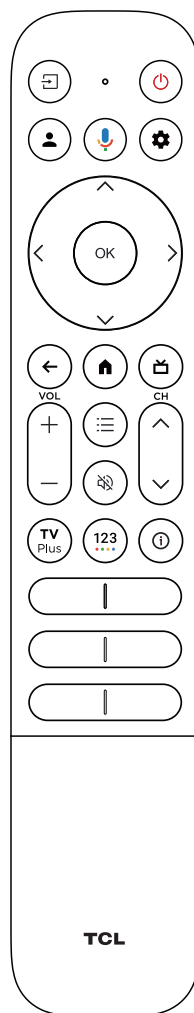

Tip! Follow the on-screen guide to pair the remote control with the TV when pressing the  button for the first time.

Step 4 Get to know your TV

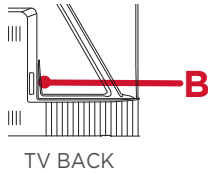
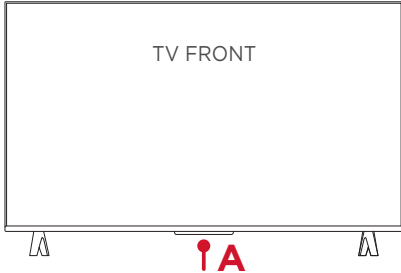

- A STATUS LIGHT** Glows when the TV is in standby.
- IR RECEIVER** Receives signal from the TV remote.
- POWER and OPTIONS BUTTON** Press once to open the menu. Press and hold to turn off the TV.
- B POWER PORT** Connect your TV to the power source with the included power cable.

- C USB PORT** Connect a USB device to access photos, music and movies.
- D ETHERNET** Connect an Ethernet cable to your home Internet router or switch.
- E HDMI* PORT** Highest quality audio/video connection. Connect cable box, Blu-ray player, gaming console, or other devices to your TV using HDMI cables.
- F HDMI (e)ARC PORT** Connect HDMI (e)ARC (audio return channel) capable audio devices like sound bars or AV receivers.
- G ANTENNA/CABLE IN** Connect an outdoor VHF/ UHF antenna or Cable TV feed.
- H AV IN adapter** AV Input (analog audio/video). The AV Input can be used to connect older devices that use analog audio/video outputs. Compatible adapter (not included) connects to the RCA cable (video - yellow and audio - white and red) that you normally use to connect to that device.
- I HEADPHONE OUT** Connect headphones or other external speakers.
- J OPTICAL (DIGITAL AUDIO OUT)** Connect an optical cable to an external digital audio system.

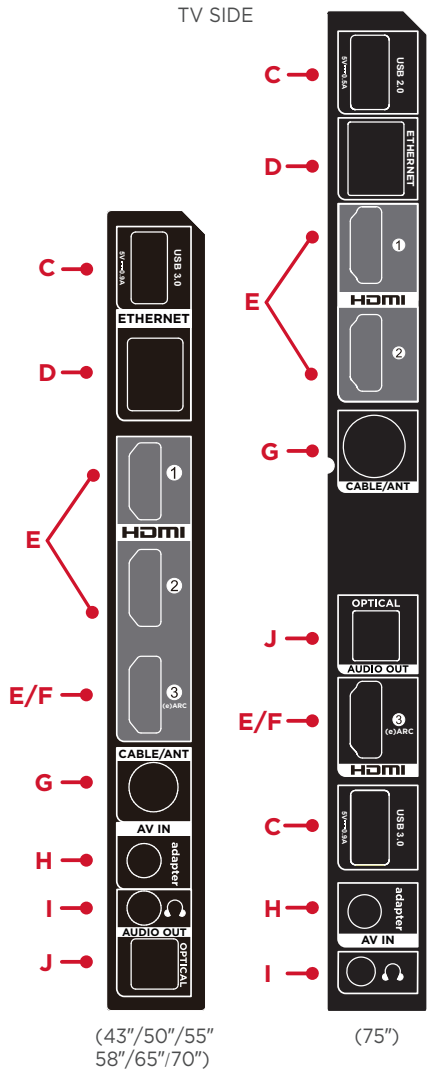

Step 5 Complete guided setup

It's the final stretch-hurray!

Let's Connect

Once your language has been selected, you can quickly set up the TV using the Google Home app on an Android or iOS phone.

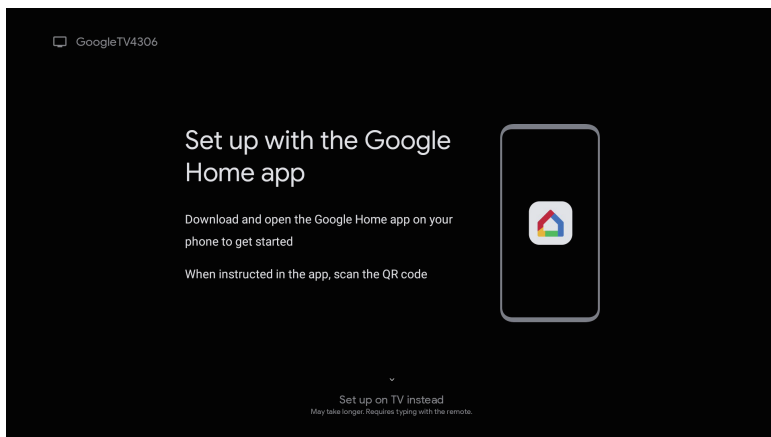

TV interface may vary and is subject to change.

The model number shown will vary depending on your TCL Google TV model number.

Or you can follow the easy on-screen instructions to setup your TV. If you aren't ready to connect your TV to a wireless network, you can still use it as a regular TV.

To enjoy all smart features and services on your TCL Google TV, a free Google account, a free TCL account, and a reliable broadband internet connection, are required.

And setup is done... Congratulations!

Continue using the remote to personalize your Home screen, streaming apps line-up, stream movies, and so much more.

Key things to know:

A paid subscription or other payments may be required for some streaming apps. Streaming apps availability are subject to change and vary by country.

WE ARE READY TO HELP

contact us first with any questions



TCL SUPPORT:
support.tcl.com/us
1-877-300-9576

TCL North America Limited Warranty

This limited consumer Product warranty is for new TCL LCD/LED Television Products consisting of the following model numbers only:

32S370G, 40S370G, 43S370G, 43S470G, 50S470G, 58S470G, 65S470G, 70S470G, 75S470G, 85S470G, 55Q670G, 65Q670G, 75Q670G (each hereinafter individually referred to as a “Product” or “Unit”, and together referred to as the “Products” or “Units”):

What your limited warranty covers: Defects in materials or workmanship to the original owner of this TCL Product when purchased as new from an Authorized Dealer of TCL brand Products in the United States and packaged with this warranty statement.

New Products (Non-Commercial Use)

For how long after your purchase:

- **Three (3) years from date of purchase** for parts and labor for **non-commercial use**.

New Products (Commercial Use)

For how long after your purchase:

- **Six (6) months from date of purchase** for parts and labor for **commercial use**. Commercial use includes, but is not limited to, the use of this Product in a commercial or business environment, the use of this Product in an institution or for institutional purposes, or for other commercial purposes including rental purposes.

What we will do

- At TCL’s discretion, (1) pay an Authorized TCL Service Center for both labor charges and parts to repair your Product, or (2) replace your Product with a new or refurbished/remanufactured equivalent value Product. The decision to repair or replace will be made solely by TCL. See section entitled “How to get service.”

How to get service

- Before submitting a request for warranty service, please visit support.tcl.com for helpful FAQs and additional troubleshooting suggestions.
- To get warranty service, contact TCL Customer Support by visiting support.tcl.com/contact-us. Please have your Product type, model number, serial number, and ZIP code ready. Troubleshooting and prior approval from a TCL representative **MUST** occur before sending in your Product to a TCL Service Center.
- A representative must troubleshoot your problem over the telephone, via chat, or through e-mail before receiving service. If it is determined that your Unit requires service, the service location will be at the sole discretion of TCL based upon the Limited Warranty Statement.
- At the sole discretion of TCL, television screen sizes 43-inches and smaller will either be repaired at an Authorized TCL Service Center or directly exchanged for a new or refurbished/re-certified Unit. At the sole discretion of TCL, television screen sizes 44-inches or larger will either be repaired or directly exchanged for a new or refurbished/re-certified Unit at an Authorized TCL Service Center or in-home. At the sole discretion of TCL, Sound Bars, and Appliances including Window Air Conditioners, Portable and Through-The-Wall Air Conditioners, Dehumidifiers, Air Purifiers, and Robot Vacuums will either be repaired or directly exchanged for a new or refurbished/re-certified Unit at an Authorized TCL Service Center or in-home. In the event of a service visit where the on-site technician, in his-her sole discretion, deems the home or property conditions to be hazardous and/or unsafe, TCL reserves the right to cancel or re-schedule the service visit, or opt for an exchange of the in-warranty Unit for a refurbished/re-certified Unit in lieu of the in-home service visit.
- TCL is not responsible for transportation costs for warranty coverage, including but not limited to Unit repair or replacement, to the Authorized TCL Service Center or TCL-designated address. However, TCL will pay for return shipping to a United States address only. TCL will provide instructions for packaging and shipping the Unit to the Authorized TCL Service Center or TCL-designated address. **Units that are improperly packed and damaged during shipping are not covered under your limited Product warranty.**
- Proof of purchase in the form of a bill of sale or receipted invoice from an Authorized Dealer which is evidence that the Product is within the warranty period must be presented to obtain warranty service.
- In the event that a Unit is to be replaced, a picture of the back of the Unit showing the model and serial number and picture of the Product issue itself may be required.
- **PRE-AUTHORIZATION MUST BE OBTAINED BEFORE (1) SENDING ANY PRODUCT TO AN AUTHORIZED TCL SERVICE CENTER, OR (2) OBTAINING ANY IN-HOME REPAIR/REPLACEMENT/RENTAL SERVICES.**

TCL North America Limited Warranty

What your warranty does not cover

- A Unit sold in “As-Is”, “Used”, “Factory Reconditioned”, “Factory Re-Certified”, or “Refurbished”, condition or with faults.
- Damage caused by transportation or handling, including damage during shipment from a Retailer (please contact your Retailer for assistance).
- Extended Service Plans purchased from Retailers. Please contact your Retailer for assistance.
- Customer instruction. (Your Owner’s Manual describes how to install, adjust, and operate your Unit. Any additional information should be obtained from your Authorized Dealer).
- Service calls to your home for delivery or pick-up, installation, instruction, replacement of house fuses, connection of house wiring or plumbing, or to correct unauthorized repairs.
- Installation and related adjustments, or damage resulting from installation.
- Damage resulting from non-approved installation or repair methods.
- Failure of the Product to perform due to signal reception problems not caused by your Unit, or due to power failures or interruptions, or inadequate electrical service.
- Damage from misuse, abuse, neglect, insects, normal wear and tear, cosmetic damage, mishandling, faulty installation, inadequate electrical wiring, or power line surges.
- Damage caused by operating the Product in a corrosive or wet atmosphere.
- Markings or images on the television’s panel resulting from viewing fixed images (including but not limited to certain 4:3 images on wide screen televisions, or data or images in fixed screen locations from banners, video games, or certain broadcast networks).
- Units that have original factory serial numbers that are unreadable or missing, or that have been changed, defaced, or altered in any manner.
- Batteries.
- A television that has been modified or incorporated into other Products, or that has had the serial number removed or altered.
- Use of accessories or components that are not compatible with this Product.
- A Unit purchased or serviced outside of the United States.
- Costs of shipping the Unit to the Authorized TCL Service Center or TCL-designated address. TCL will pay for return shipping to the customer to a United States address only.
- Acts of nature or God (as illustrative examples and for the avoidance of doubt, such acts of nature or God include but are not limited to damage caused by earthquakes, fires, lightning, or flood whether caused by nature or humans).
- Special, incidental, or consequential damages.

LIMITATION OF WARRANTY

- THE WARRANTY STATED ABOVE IS THE ONLY WARRANTY APPLICABLE TO THIS PRODUCT. NO VERBAL OR WRITTEN INFORMATION GIVEN BY TTE TECHNOLOGY, INC. DBA TCL NORTH AMERICA, ITS AGENTS OR EMPLOYEES SHALL CREATE A GUARANTY OR IN ANY WAY INCREASE OR MODIFY THE SCOPE OF THIS WARRANTY.
- REPAIR OR REPLACEMENT AS PROVIDED UNDER THIS WARRANTY IS THE EXCLUSIVE REMEDY OF THE CONSUMER. TTE TECHNOLOGY, INC. DBA TCL NORTH AMERICA SHALL NOT BE LIABLE FOR SPECIAL, INCIDENTAL, OR CONSEQUENTIAL DAMAGES RESULTING FROM THE USE OF THIS PRODUCT OR ARISING OUT OF ANY BREACH OF ANY EXPRESS OR IMPLIED WARRANTY ON THIS PRODUCT. THIS DISCLAIMER OF WARRANTIES AND LIMITED WARRANTY ARE GOVERNED BY THE LAWS OF THE STATE OF CALIFORNIA. EXCEPT TO THE EXTENT PROHIBITED BY APPLICABLE LAW, ANY IMPLIED WARRANTY OF MERCHANTABILITY OR FITNESS FOR A PARTICULAR PURPOSE ON THIS PRODUCT IS LIMITED TO THE APPLICABLE WARRANTY AND WARRANTY PERIOD SET FORTH ABOVE. THIS WARRANTY IS SUBJECT TO CHANGE WITHOUT NOTICE. PLEASE VISIT WWW.TCL.COM TO VIEW THE MOST CURRENT VERSION.

How State Law relates to this warranty

- Some states may not allow the exclusion or limitation of incidental or consequential damages, or limitations on how long an implied warranty lasts, so the above limitations or exclusions may not apply to you.
- This warranty gives you specific legal rights, and you also may have other rights that vary from state to state.

If you purchased your Unit outside of the United States or seek warranty service coverage outside of the United States, this warranty does not apply. Contact your dealer for warranty information.

Service calls which do not involve defective materials or workmanship are not covered by this limited warranty. Costs of such service calls are the sole responsibility of the purchaser.

Broadcasting & Operating Environment

Broadcasting system	US System NTSC-M ATSC standard (8VSB), QAM
Receiving Channels	VHF2-13 UHF14-69 CATV 14-36 (A)-(W) 37-59 (AA)-(WW) 60-85 (AAA)-(ZZZ) 86-94 (86)-(94)95-99 (A-5)-(A-1) 100-135 (100)-(135) 01 (4A)
Tuner type	Frequency synthesized
Operating Temperature	5°C to 35°C (41°F to 95°F)
Operating Humidity	20% to 80%, non-condensing
Storage Temperature	-15°C to 45°C (5°F to 113°F)
Storage Humidity	10% to 90%, non-condensing

Troubleshooting

Having trouble completing the guided setup? Don't worry, it's usually an easy fix.

Cannot connect to wireless network (WiFi)

- Select the correct wireless network name and verify the password entered (case sensitive).
- Relocate the router from objects that interfere with performance (cordless phones, baby monitors, etc.).
- Reboot the router by disconnecting the power for more than 2 minutes and reconnect.

Problems connecting my cable box or antenna through a coax cable

- For best performance, use the HDMI connection. If not available, then:
- Make sure the cable connections to the TV and your device are securely fastened.
- Select cable or antenna input.
- Select the channel scan menu and follow the on-screen instructions to perform a full channel scan.

What is the remote code for programming my Universal or Cable box remote control?

- Please visit <https://go.tcl.com/codes>

Access parental control

- The initial personal password for your TV is 1234.
- You can change the personal password anytime.
- If you forget your personal password, you can use 0423 to reset.

How do I turn Text-to-Speech (TTS) on or off?

- Press Settings button (⚙️) on the remote control
- Select "Settings".
- Select "System".
- Select "Accessibility".
- Select "TalkBack".
- Select "Enable" and press OK to turn it on or off.
- For more information visit: <https://go.tcl.com/tts-gtv>

How to use voice control through the remote control?

- In Google TV mode, press and hold the "HOME" and "OK" buttons on your remote at the same time.
- Keep your remote within 3 ft. of your TV during the pairing process.
- Then, when the TV display shows that the Google Assistant is ready – speak towards the remote microphone by holding down the Google Assistant button to ask a question or try a suggestion.

Need more help?

support.tcl.com/us

1-877-300-9576

Home Theater, Made Simple.

Complete your Home Theater Experience with a TCL Sound Bar!



Upgrade your TV speakers with the all-new TCL S-Series Sound Bars offering premium audio with true surround sound, crisp clarity, and deep bass for all your favorite entertainment.

Available features include DTS® Virtual:X™, Bluetooth® streaming, a powerful wireless subwoofer, surround sound speakers and up to 300 watts of audio power.

S4510

Learn more at [TCL.com](https://www.tcl.com) or visit your favorite retailer.

TCL

Copyright © 2023 by TCL. All rights reserved.
TCL and the TCL Logo are owned by TCL Corporation and under license to TCL North America. Other brand and product names are the trademarks or registered trademarks of their respective owners.

TCL North America
189 Technology Drive, Irvine, CA 92618, USA



Part No.: 280201033691